

MIKI - 1171 Automatic Urinal Sensor

MIKI - 1171 尿兜感應器

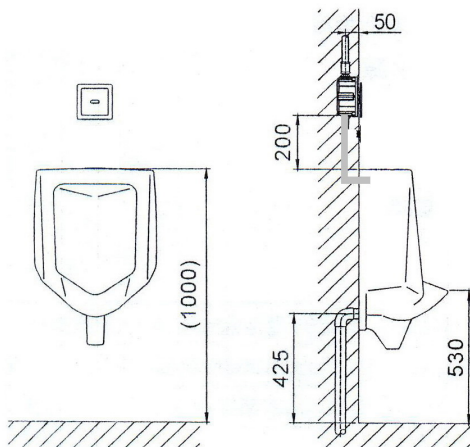

Characteristic:

- Hygienic the whole rinsing process is done by the flusher itself, clean and efficient. The hands-free feature can keep you free from bacteria infection, especially in busy restrooms.
- Suitable places it is suitable for ordinary public places.
Intelligent it can control its flushing time according to use frequency and duration intelligently, saving water more efficiently.
- Low power consumption for DC type, Lithium batteries can be used for 1 year at 100 cycles a day.
- Trap seal protection it will flush automatically every 24 hours if not used to avoid the odor returning once the trap dries.
- Power optional both AC and battery power are available for your option.

Technical information:

Power supply	DC: 6V, Lithium batteries, installed before leaving factory; AC: 220v-6v
Recognize range	35cm

Sensor Plate Size : 126 x 126 mm
Control Box Size : 200 x 130 x 65 mm